

## REMEDY® STEMMED KNEE SPACER

Temporary REMEDY® Stemmed Knee Spacer with Gentamicin

1



**REMEDY®**  
Femoral Component



**REMEDY®**  
Tibial Component



**REMEDY®**  
Tibial Insert Wedge



**REMEDY®**  
Stem Component

### Overview

The REMEDY® Stemmed Knee Spacer is part of the treatment foreseen in a two-stage procedure performed in the event of permanent prosthesis infection.

The REMEDY® Stemmed Knee Spacer implant is intended for temporary use only (180 days or less). It allows basic joint mobility and releases antibiotic into the joint area and adjacent to the device to protect the implant from bacterial colonization.

A second surgery will be required at a later date to remove the REMEDY® Stemmed Knee Spacer and replace it with a permanent knee joint implant.

The REMEDY® Stemmed Knee Spacer is a temporary knee spacer device consisting of independent components (femoral component, tibial component and stem extension components) that can be combined one with each other depending on the anatomy of the patient. These components are available in different sizes to further accommodate variations in patient anatomy.

The REMEDY® Stem Extension Components can be coupled with both the REMEDY® Stemmed Femoral and the REMEDY® Stemmed Tibial Components, as they are intended to be used, if necessary, to replace the space occupied by the previous femoral and/or tibial stem. REMEDY® Stem Extensions have an inner reinforcing structure in AISI 316ESR (ASTM F138, ISO 5832-1) coated with bone cement (PMMA) with gentamicin. In addition the REMEDY® Stemmed Tibial Component could be also coupled, if necessary, with the corresponding size of commercially marketed REMEDY® Tibial Insert Wedge, when a large tibial defect is present.

Each REMEDY® Stemmed Femoral Component (four sizes available) is matchable to each REMEDY® Tibial Component (three sizes available). The REMEDY® Stem Extension Component is available in four sizes. Each REMEDY® Tibial Insert Wedge (three sizes available) is matchable only with its corresponding Tibial Component.

The REMEDY® Stemmed Knee Spacer is a single-use, ethylene oxide sterile medical device. The REMEDY® Stemmed Knee Spacer is made of formed bone cement (PMMA) with gentamicin. The REMEDY® Stem extensions have an inner reinforcing structure in AISI 316ESR (ASTM F138, ISO 5832-1). The REMEDY® Stemmed Knee Spacer releases gentamicin.

**REMEDY® Stemmed Knee Spacer Indications**

The REMEDY® Stemmed Knee Spacer, which consists of a modular femoral, tibial and stem extension components, is indicated for temporary use (maximum 180 days) as an adjunct to total knee replacement (TKR) in skeletally mature patients undergoing a two-stage procedure due to a septic process and where gentamicin is the most appropriate antibiotic based on the susceptibility pattern of the infecting micro-organism(s).

The device is applied on the femoral condyles (femoral component) and on the tibial plate (tibial component) following removal of the existing implant and radical debridement. The use of the stem extension component is optional to replace the space occupied by the previous femoral and/or tibial stem (dead space management). Moreover, if necessary, the tibial component could be coupled with the OsteoRemedies REMEDY® Tibial Insert Wedge when a large tibial defect is present.

The device is intended for use in conjunction with systemic antimicrobial antibiotic therapy (standard treatment approach to an infection).

The REMEDY® Stemmed Knee Spacer is not intended for use for more than 180 days, at which time it must be explanted and a permanent device implanted or another appropriate treatment performed (e.g. resection arthroplasty, fusion etc.). Because of the inherent mechanical limitations of the device materials (gentamicin/polydimethylmethacrylate), the device is only indicated for patients who will consistently use traditional mobility assist devices (e.g., crutches, walkers, canes) throughout the implantation period, allowing basic joint mobility.

**REMEDY® Stemmed Knee Spacer Contraindications**

- Deficiencies in the patient's vascular, nervous or muscular systems.
- Osteoporosis or poor bone quality may cause the implant to fracture existing bone or migrate.
- Sufficient bone not available to allow insertion and fixation of the knee spacer.
- Patient's two-stage arthroplasty procedure is contraindicated based on decreased immune response or systemic clinical conditions.
- The infected TKR devices cannot be removed.
- Patient exhibits hypersensitivity (allergy) to PMMA bone cement, aminoglycosides or gentamicin.
- Lack of adequate bone structure which precludes adequate support of the spacer.
- Lack of adequate competence (anatomical and functional) of peripheral ligamentous apparatus and extensor mechanism.
- Infection of the TKR cannot be confirmed.
- Infecting bacterium/pathogens resistant to gentamicin.
- Infecting bacterium/pathogens are not susceptible to gentamicin.
- A remote infection (systemic/secondary) is suspected or verified.
- Myasthenia gravis.
- The patient does not have a TKR and the infection is secondary to trauma, septic arthritis or other surgical procedures.
- The patient has neuromuscular disorders that do not allow control of the knee joint.
- Patient is unable or rejecting the use of protected weight bearing devices throughout the implantation period (canes, walkers, crutches, etc.).
- Age, weight or activity level, may cause the surgeon to expect possible, early failure of the knee spacer.

**Possible Adverse Events**

The list provided below addresses frequent and serious adverse effects which may be associated with the use of the REMEDY® Stemmed Knee Spacer. Note that some effects are not directly associated with the device itself; however, the surgeon should be aware of these possible issues, and ready to treat them accordingly.

**Surgical Risks (General):** pulmonary embolism, myocardial infarction, arrhythmias, venous thrombosis, transitory hypotension.

**Surgery Risks (TKR):** difference in limb length, wound healing issues, femur or tibia damage, blood vessel damage, nerve damage, bone bed damage, excessive blood loss, arthrofibrosis, phlebitis, thrombophlebitis, hematoma.

**REMEDY® Stemmed Knee Spacer Risks:** recurring infection, gentamicin toxicity (ototoxicity/nephrotoxicity), implant breakage, implant loosening, PMMA sensitivity, debris release, difficult device removal, implant dislocation, foreign body reaction, metallic material related allergies.

**NOTES:** *The surgeon should be aware of the possible negative effects of bone cement, as the device must be affixed with it. Infections that recur, though rare, have been known to reappear even with IV antibiotic use. Gentamicin application may trigger negative reactions of this antibiotic following systemic use, as shown in the next paragraphs.*

*In case of breakage of the REMEDY® Stem Extension Implant, the inner reinforcing structure in AISI 316ESR could come in contact with the surrounding tissues. The surgeon should be aware of potential material related allergies in patients with metal hypersensitivity to implant materials.*

#### **GENTAMICIN (and Aminoglycosides) Risks**

All aminoglycosides have the potential to produce reversible and irreversible vestibular, cochlear and renal toxicity.

**Ototoxicity:** Vestibular and auditory dysfunction can follow the administration of any of the aminoglycosides. It is more likely to occur in patients with persistently elevated concentrations of drug in plasma. Ototoxicity is largely irreversible and results from progressive destruction of vestibular or cochlear sensory cells, which are highly sensitive to damage by aminoglycosides. Repeated courses of aminoglycosides can lead to deafness. Older patients may be more susceptible to ototoxicity. Drugs such as ethacrynic acid and furosemide potentiate the ototoxic effects of the aminoglycosides in animals, but data from humans implicating furosemide are less convincing. Hearing loss is more likely to develop in patients with pre-existing auditory impairment following exposures to these agents. It is recommended that patients receiving high doses and / or prolonged courses of aminoglycosides be monitored carefully for ototoxicity, since initial symptoms may be reversible. However, deafness may occur several weeks after therapy is discontinued.

**Nephrotoxicity:** Approximately 8-26% of patient receiving an aminoglycoside for several days will develop mild renal impairment that is almost always reversible. Toxicity is correlated with the total amount of drug administered. Other drugs, such as amphotericin B, vancomycin, angiotensin-converting enzyme inhibitors, cisplatin and cyclosporine may potentiate aminoglycoside-induced nephrotoxicity. Monitoring drug concentrations in plasma is useful, particularly during prolonged and/or high dose therapy.

**Neuromuscular blockade:** Neuromuscular blockade generally has occurred after intrapleural or intraperitoneal instillation of large doses of an aminoglycoside; however, the reaction can follow intravenous, intramuscular and even oral administration of these agents. Most episodes have occurred in association with anesthesia or administration of other neuromuscular blocking agents. Patients with myasthenia gravis are particularly susceptible to neuromuscular blockade by aminoglycoside.

**Other untoward effects:** Aminoglycosides have little allergenic potential; anaphylaxis and rash are unusual. Rare hypersensitivity reactions, - including skin rashes, eosinophilia, fever, blood dyscrasia, angioedema, exfoliative dermatitis and anaphylactic shock - have been reported as cross-hypersensitivity among drugs in this class.

**Note:** Allergic reaction may appear independent to dosage.

### Pregnancy and Breast-feeding

There are no existing data that illustrates the usage safety of the REMEDY® Stemmed Knee Spacer during pregnancy and breast-feeding. It is recommended that knee revision surgery be avoided during the first three months of pregnancy. The REMEDY® Stemmed Knee Spacer can be used in the remaining gestation time only when it is determined that it is impossible to save the joint or preserve the patient's life by other means of intervention.

### Use in Children

No data or tests support that the REMEDY® Stemmed Knee Spacer is safe to use in children. The REMEDY® Stemmed Knee Spacer should only be used in mature adults.

### GENTAMICIN SULPHATE

#### Chemistry/Structure

Gentamicin is an aminoglycoside antibiotic derived by the growth of an actinomycete, *Micromonospora purpurea*. Gentamicin is a complex of the gentamicins C1, C1a, C2 C2a and C2b as shown. The molecular weight is 449.55. The compound is supplied as sulphate.

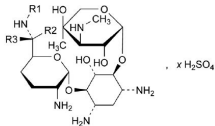

Gentamicin	Mol. Formula	R1	R2	R3
C1	C <sub>21</sub> H <sub>43</sub> N <sub>5</sub> O <sub>7</sub>	CH <sub>3</sub>	CH <sub>3</sub>	H
C1a	C <sub>19</sub> H <sub>39</sub> N <sub>5</sub> O <sub>7</sub>	H	H	H
C2	C <sub>20</sub> H <sub>41</sub> N <sub>5</sub> O <sub>7</sub>	H	CH <sub>3</sub>	H
C2a	C <sub>20</sub> H <sub>41</sub> N <sub>5</sub> O <sub>7</sub>	H	H	CH <sub>3</sub>
C2b	C <sub>20</sub> H <sub>41</sub> N <sub>5</sub> O <sub>7</sub>	CH <sub>3</sub>	H	H

### GENTAMICIN SULPHATE RELEASED FROM PMMA

#### Mechanism of Action

Bacteria tend to adhere to surfaces where they can multiply and create a defensive barrier called a biofilm (complex structure mainly made by extracellular polysaccharides and proteins). Bacteria embedded in a biofilm are more resistant to most antibiotic therapy because the glycoprotein structure is difficult for antimicrobial agents to penetrate. PMMA, due to its surface characteristics, is one of the materials with the highest risk of bacterial colonization. It has been demonstrated in vitro that the presence of antibiotics in PMMA reduces bacterial adhesion.

Gentamicin is rapidly bactericidal. It binds to the prokaryotic ribosome and interferes with protein synthesis by causing misreading and premature termination of mRNA translation leading to altered cell membrane permeability, progressive disruption of the cell envelope as well as other vital processes and cell death.

#### Antibacterial Activity

Gentamicin activity is primarily directed against aerobic, gram negative bacilli. The action against most gram positive bacteria is limited. In vitro it is bactericidal against Gram-positive and Gram-negative bacteria.

Gentamicin is active against susceptible strains of enterococci and streptococci at concentrations that can be achieved clinically only when combined with a penicillin or vancomycin. Gentamicin has been shown to be active against most strains of the following organisms both in vitro and in clinical infections.

#### Common susceptible pathogens (\*)

##### Gram positive bacteria

Staphylococcus aureus,  
Streptococcus pyogenes  
Streptococcus pneumoniae  
Streptococcus faecalis  
Listeria monocytogenes

**Gram Negative Bacteria**

Citrobacter	Morganella morganii
Enterobacter	Providencia spp.
Escherichia coli	Salmonella spp.
Klebsiella spp.	Serratia
Proteus mirabilis	Shigella spp.
Proteus vulgaris	Pseudomonas aeruginosa

*\*Kucers A, Bennett N. The use of antibiotics 4th Ed. 1987, Butterworth-Heinemann Ltd.*

**Bibliography**

Goodman & Gilman's The Pharmacological Basis of Therapeutics - 2011, XII Ed., Chapter 54 (Henry F. Chambers); McGraw Hill, New York.  
*Kucers A, Bennett N. The use of antibiotics - 4th Ed. 1987, Butterworth-Heinemann Ltd (\*)*

**Antibiotic Warnings**

*In vitro* elution studies (microbiological method) has shown that the daily release of gentamicin never exceeds the recommended systemic adult dose for gentamicin (5-7 mg/kg/day) according to the Goodman and Gilman's recommendations (adults with normal renal function). Toxic levels are not expected when gentamicin is released locally from the REMEDY® Stemmed Knee Spacer. However, trough concentrations exceeding 2 µg/ml for longer than 10 days have been associated with toxicity (systemic administration). The REMEDY® Stemmed Knee Spacer should be used with caution, during the first day of implantation, when used in conjunction with ototoxic or nephrotoxic drugs. The device should be used with caution in patients predisposed to or who have preexisting medical conditions that would put them at risk for gentamicin toxicity (dehydration, renal dysfunction, advanced age, etc.). All patients should be monitored for toxic blood levels of gentamicin, nephrotoxicity and ototoxicity while the device is in situ: this is especially critical for elderly patients and those receiving other ototoxic and/or nephrotoxic drugs.

**Precautions**

Review of the OsteoRemedies® LLC surgical technique for knee arthroplasty revision surgery and familiarity with the proper use of the REMEDY® Stemmed Knee Spacer is required for successful implantation of the device. Only surgeons who have studied the REMEDY® Stemmed Knee Spacer surgical technique and are aware of the limitations of its application are allowed to perform the procedure. The surgeon is not allowed to adjust or modify the device in any way (do not add additional antibiotics as the effects structurally and pharmacologically cannot be known). The user must protect the device from harm as any damage to the implant may reduce fatigue strength and may result in failure under load thus possibly affecting the patient. If particulate debris becomes detached (loose fragments of bone or bone cement) the wear rate of component contact surface is greatly accelerated as debris acts as an abrasive and damaging anomaly. The REMEDY® Stemmed Knee Spacer may be compromised in an overweight or obese patient and/or one who does not limit the amount of activity and weight placed on the knee. Always use the largest component size possible to ensure ideal performance. It is essential that the patient use mobility-assisted devices (e.g. crutches, walker, cane) during the implantation period.

Care should be taken in placing the spacer to preserve the bony tissue during the implantation procedure. Implantation methods which are deemed aggressive are not needed for proper placement of the spacer. Any damage to the device may affect the fatigue strength and lead to failure under load, therefore do not subject the device to excessive forces (mallet strikes). Antibiotic susceptibility testing should be performed prior to implantation of the REMEDY® Stemmed Knee Spacer following a fine needle aspiration from the joint site. Patients should be informed of the limitations of the implant and the requirement for additional surgery to implant a permanent knee prosthesis. Patients should be instructed to adjust their activities and be informed that postoperative care is essential.

The REMEDY® Stemmed Knee Spacer is single-use intended for an individual patient. Do not resterilize and/or reuse. Resterilization of the components can cause risk of infection to the patient and may change the morphology of the device, the effectiveness of the antibiotic component and mechanical properties of the implant, that could cause a malfunction with serious health risks for the patient.

Implants should not be reused once removed, though they may appear not damaged as this could cause contamination and aggravation of patient infection. The removal of the device may damage the implant itself, and cement residues may remain adhered as well to the device. By not following these recommendations there will be an increased likelihood of wear, loosening, poor function, fracture or premature failure. Excess material is deemed as surgical waste and must be removed/destroyed at the conclusion of the surgical procedure.

The REMEDY® Stemmed Knee Spacer should not be implanted if the existing implant cannot be completely removed.

The REMEDY® Stemmed Knee Spacer is comprised of two components (femoral component, tibial component). If necessary, REMEDY® Stem Extension Component or REMEDY® Tibial Insert Wedge can be used. It is important not to use the individual components alone within the anatomy.

The REMEDY® Stemmed Knee Spacer must not be rinsed or cleaned with liquids prior to implanting.

The REMEDY® Stemmed Knee Spacer should not be used in areas that contain osteosynthesis implants that may interfere with the device and its mechanical function.

The REMEDY® Stemmed Knee Spacer must not remain implanted for more than 180 days. The operative area should be rigorously irrigated and rinsed after device extraction to remove all cement debris prior to implantation of the permanent prosthesis or other surgical procedures (fusion, resection arthroplasty, etc.). Survival of the revision implant may be jeopardized if cement and/or bone debris are not thoroughly removed. The device has specific indications for use. Thus its use under conditions other than the intended ones is unlikely to provide any benefit to the patient, and increases the risk of developing drug-resistant bacteria.

**Note:** When the Extra-Large Femoral Component is being used in combination with the Large Tibial Component, Large Tibial Insert Wedge, and 230mm Stem Extension, only one stem Extension should be used. The use of an additional stem extension of any size in this combination of components has not been evaluated for gentamicin toxicity.

#### **Implantation/Utilization**

Aseptic surgical techniques are critically important based on clinical study data. Correct sizing of the REMEDY® Stemmed Knee Spacer depends on the selection and judgment of the surgeon in relation to the patient's anatomy and need. In order for the surgeon to effectively implant the device the surgeon shall:

(A) study available literature, (B) properly and thoroughly train on the techniques required for the REMEDY® Stemmed Knee Spacer surgery, and (C) study and become informed regarding the use of instrumentation for sizing and implantation of the devices.

REMEDY® Stemmed Knee Trial devices are also available to ensure the implant has been correctly sized for the patient's anatomy.

**Warning:** The REMEDY® Stemmed Knee Spacer must be cemented with gentamicin-loaded cement. The use of bone cement is compulsory to achieve stability and to limit the risk of dislocation or spacer loosening.

### Application Instructions

The medial para-patellar route is typically utilized for the insertion of the REMEDY® Stemmed Knee Spacer.

The operative site must be irrigated with Ringer or physiological solution while thorough debridement must be executed after removal of the prosthesis and before inserting the REMEDY® Stemmed Knee Spacer. Excess cement or debris from the previous device must be removed to ensure a clear operative area.



### Size Selection

The size is selected in relation to the dimensions of the removed implant, the type of bone defect, the condition of the ligamentous apparatus and the flexion-extension spaces. Other consideration shall be given in relation to the stability of the implant and the range of movement: the achievement of full extension and 90° flexion is important, in particular with a flexion area sufficiently dose to avoid antero-posterior movement of the flexed knee. Correct measurement can be determined by measuring the removed tibial and femoral components along with the use of REMEDY® Stemmed Knee Trial.

**Note:** When the Extra-Large Femoral Component is being used in combination with the Large Tibial Component, Large Tibial Insert Wedge, and 230mm Stem Extension, only one stem Extension should be used.

### Trial Use

Using the REMEDY® Stemmed Knee Spacer Trials, select the appropriate size femoral and tibial components. If a stem extension is necessary, select between the four available lengths and two diameter options and place through the opening of the femoral and/or tibial stemmed trial components to ensure the stem is able to be fully seated. It is important that the joint is neither loose nor tight, therefore the surgeon will have to consider the additional room occupied by the cement needed for the fixation.

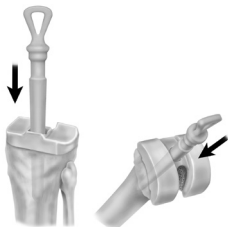

### REMEDY® Stemmed Knee Spacer Use

Apply UNITE® AB Bone Cement (or any FDA cleared gentamicin-loaded cement) over the tibial component surface in contact with the bone and tibial plateau.

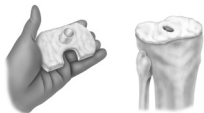

**OPTIONAL:** If the tibial bone defect is excessive and additional height is required, apply cement to the tibial insert wedge and cement it to the inferior aspect of the tibial component.



With additional cement fill the housing of the tibial component, insert the conical tip of the selected stem extension and complete the stem fixation by using cement around stem and housing connection. If additional fixation is necessary, cement may be applied to the nearest pocket of the stem extension component. Give the stem the necessary angulation, up to 8° in all the directions, to match the patient's tibial canal anatomy. Then insert the construct into the tibia while cement is still in a moldable phase avoiding allowing excess cement to adhere to the joint surfaces. Remove the cement from the posterior tibial intercondylar notch.

**Note:** if the stem extension is not used, cement will be used only for fixation of the tibial component itself.

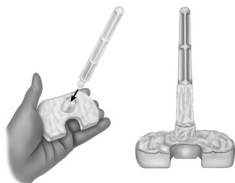

for the

Apply UNITE® AB Bone Cement (or any FDA cleared gentamicin-loaded cement) over the femoral component in contact with the bone and femoral surface.

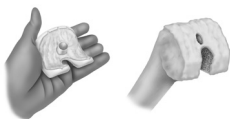

Apply cement into the housing of the femoral component, insert the conical tip of the selected stem extension and complete the stem fixation by using cement around stem and housing connection. If additional fixation is necessary, cement may be applied to the nearest pocket of the stem extension component. Give the stem the necessary angulation, up to 8° in all the directions, to match the patient's femoral canal anatomy.

Then insert the construct into the femur while cement is still in a mouldable phase avoiding allowing excess cement to adhere to the joint surfaces. Remove the cement from the posterior femoral intercondylar notch.

**Note:** if the stem extension is not used, cement will only be needed for the fixation of the component itself.

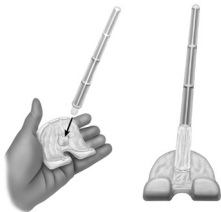

Reduce the joint, removing all the excess cement, avoiding that cement may go onto the articular surface. To assure correct alignment of the components, make flex/extension movements before the cement curing occurs. DO NOT forcefully bring the knee into full extension as too much force could lead fracture of the femoral or tibial components. Then, close and check flex/extension movements and lateral stability. Depending on the stability of the knee, it may be necessary to apply a brace to avoid the risk of dislocation.





**Note:** When placing the components with cement, DO NOT impact the device with a mallet. It is recommended to use hand pressure only while placing the components.

To prevent dislocation, the same measures utilized for a permanent total knee replacement should be adopted.

**Additional considerations include:**

- Instructions, techniques or guides for the spacer device.
- Choice of the correct size.
- Proper cement fixation of the components with gentamicin-loaded bone cement. Missing or insufficient cement especially in the posterior portion of the condyles - may weaken the structure of the device.
- Placement with appropriate joint tension of the soft tissues around the knee joint.
- In cases at risk consider the use of a brace (possibly articulated) to assist in flexion to lower the risk of dislocation.
- Application in at risk cases of an orthopaedic brace (possibly articulated) to assist flexion without dislocation.
- Explanation of the spacer device.

**Note:** *The REMEDY® Stemmed Knee Spacer has not been evaluated for safety and compatibility in the MR environment. It has not been tested for heating, migration, or image artifact in the MR environment. The safety of REMEDY® Stemmed Knee Spacer in the MR environment is unknown. Scanning a patient who has this device may result in patient injury.*

**Postoperative Treatment**

Postoperative treatment is comparable with a primary knee implant, however, weight-bearing can be only partial (use of canes, crutches, etc.). It is recommended that partial weight-bearing be assessed on an individual basis in relation to the anatomic conditions of the femur and tibia, bone trophism and the clinical conditions of the patient during rehabilitation stages. Avoid weight bearing or forced mobilization which could cause the implant to damage the biological structure. If needed, a brace (possibly articulated) to assist flexion may be suggested in cases at risk of dislocation (in relation to the stability and/or the condition of the extensor apparatus).

**Explanation**

The REMEDY® Stemmed Knee Spacer must be removed within 180 days of implantation and is not intended for use as a permanent prosthesis. Revision instruments (mallets, osteotomes, etc.) can be used in the surgical procedure. The wound site should thoroughly be cleaned of all bone cement debris prior to implantation of a definitive implant or performing an alternative surgical procedure (e.g. resection arthroplasty, fusion, etc.). Cement or bone debris may shorten the survival of the revision implant if not removed.

**Disposal**

Disposal of the device should be in accordance with local waste regulations.

### Patient Precautions

Surgeon-to-patient instructions

- Pain, discomfort or trauma with the affected limb must be communicated to the surgeon.
- Canes, crutches, walkers, etc., (protected weight-bearing mobility devices) must be used at all times while the device is implanted.
- The REMEDY® Stemmed Knee Spacer must be removed after temporary implantation (not to exceed 180 days).
- Excessive loading/weight on the REMEDY® Stemmed Knee Spacer must be averted (sports activity, obesity, falling, unprotected weight bearing, etc.).

The patient's anatomic conditions of the knee district, bone trophism and other relevant clinical conditions during the rehabilitation phase should be periodically reviewed as the REMEDY® Stemmed Knee Spacer was designed for temporary implantation under protected load bearing conditions.

### How Supplied

The REMEDY® Stemmed Knee Spacer implants are packaged and distributed sterile. Do not resterilize. All packages should be inspected for integrity prior to use. If a package is opened, contaminated or damaged please do not use.

### Caution

Federal Law restricts this device to sale by or on the order of a physician.

### Information

For further product information, please contact Customer Service.

---

### Symbols

---



Catalog  
Number



Batch  
Code



Consult  
Instruction  
For Use



Do Not  
Reuse



Do Not Use  
If Package Is  
Damaged



Sterilized  
Using Ethylene  
Oxide



Do Not  
Resterilize



Use By  
Date



Caution

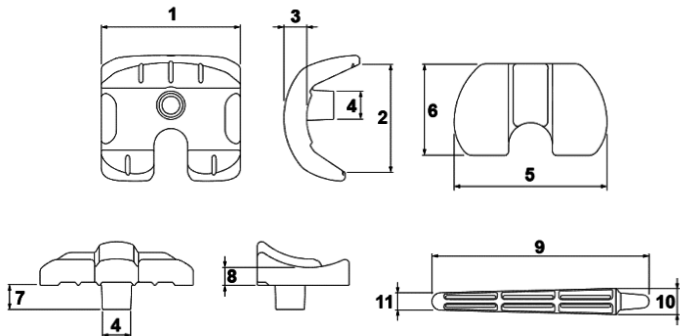

### Component Description

	1(mm)	2(mm)	3(mm)	4(mm)	5(mm)	6(mm)	7(mm)	8(mm)	9(mm)	10(mm)	11(mm)	Gentamicin Base (g)
REMEDY* Stemmed Femoral Component SM	54	41.6	9.5	14	-	-	-	-	-	-	-	0.6
REMEDY* Stemmed Femoral Component MD	64	49.3	10.5	14	-	-	-	-	-	-	-	0.9
REMEDY* Stemmed Femoral Component LG	74	56.3	11.5	14	-	-	-	-	-	-	-	1.2
REMEDY* Stemmed Femoral Component XL	78	63.4	12.5	14	-	-	-	-	-	-	-	1.6
REMEDY* Stemmed Tibial Component SM	-	-	-	14	60	36	11	7.8	-	-	-	0.4
REMEDY* Stemmed Tibial Component MD	-	-	-	14	70	42	11	8.2	-	-	-	0.6
REMEDY* Stemmed Tibial Component LG	-	-	-	14	80	48	11	8.8	-	-	-	0.8
REMEDY* Stem Extension Component 100 - 12/8 OD	-	-	-	-	-	-	-	-	100	12	8	0.1
REMEDY* Stem Extension Component 150 - 13/11 OD	-	-	-	-	-	-	-	-	150	13	11	0.1
REMEDY* Stem Extension Component 175 - 12/8 OD	-	-	-	-	-	-	-	-	175	12	8	0.1
REMEDY* Stem Extension Component 230 - 13/11 OD	-	-	-	-	-	-	-	-	230	13	11	0.2

For Internal Use



---

Manufactured By:

---



6800 Poplar Avenue | Suite 120 | Memphis, TN 38138

---

901.453.3141 | [info@OsteoRemedies.com](mailto:info@OsteoRemedies.com) | [OsteoRemedies.com](https://OsteoRemedies.com)

OsteoRemedies, REMEDY, SPECTRUM and the corporate mark are trademarks of OsteoRemedies, LLC

©2023 • 0123 V2